

COMEXIO Retro-Speaker

SPo10



Beschreibung

Der Retro-Speaker ist als Wand- und Regallautsprecher perfekt zum Nachrüsten geeignet und überzeugt durch schlichtes Design und bombastischen Klang. Pro Raum empfehlen wir die Verwendung von zwei Retro-Speakern.

Installation

Die Installation darf nur durch eine Elektrofachkraft oder eine elektrotechnisch unterwiesene Person erfolgen.

Technische Highlights

- Ideal für das COMEXIO Multiroom-System geeignet
- 2 Wegesystem
- Eignet sich für Wand und Regal
- Koaxialsystem
- Dezente Optik, fügt sich in viele Inneneinrichtungen ein
- Inkl. Wandhalter mit Kugelgelenk
- Für horizontale und vertikale Montage geeignet

Description

The Retro-Speaker, as a wall and shelf speaker, is perfect for retrofitting and convinces with simple design and bombastic sound. We recommend two Retro-Speaker per room.

Installation

The installation may only be carried out by a qualified electrician or a person trained in electrical engineering.

Technical Highlights

- Ideally suited for the COMEXIO Multiroom system
- 2 Way system
- Suitable for wall and shelf
- Coaxial system
- Discreet look, fits into many interiors
- Incl. wall bracket with ball joint
- Suitable for horizontal and vertical mounting

Technische Daten

Retro-Speaker (SP010)

Technical Data

Typ Type	2-Wege-Koaxiallautsprecher 2-way coaxial loudspeaker
Nennbelastbarkeit Rated power	40 W
Maximalbelastbarkeit Maximum power	70 W
Nennimpedanz Nominal impedance	4 Ohm
Übertragungsbereich Frequency response	70-22000 Hz
Mittlerer Schalldruckpegel Mean sound pressure level	84 dB (1 W/1 m)
Abstrahlwinkel (-6 dB) Opening angle (-6 dB)	88°/4000 Hz
Resonanzfrequenz f_s Resonance frequency f_s	110 Hz
Anschlüsse Connections	4,8 x 0,8 mm (+) 2,8 x 0,8 mm (-)
Temperaturbereich Temperature range	-25 ... 70 °C
Kabeleinlass Durchmesser Cable inlet diameter	2,0 x 5,0 mm
Produktmaße (BxHxT) Product dimensions (WxHxD)	(283 mm x 143,41 mm x 108,09 mm)
Schutzart Protection class	IP40
Schutzklasse Protection class	III
Gewicht (Netto) Weight (Net)	2100 g

Maßzeichnung

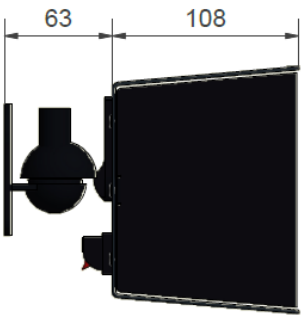
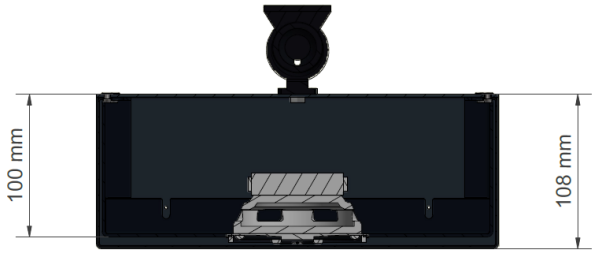
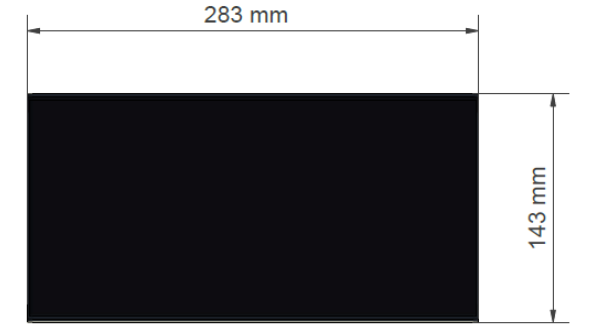

Dimensional drawing

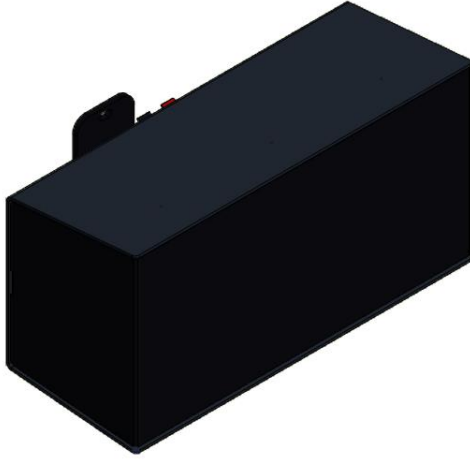
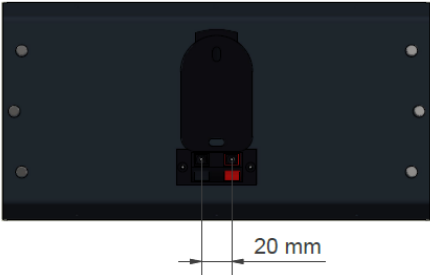



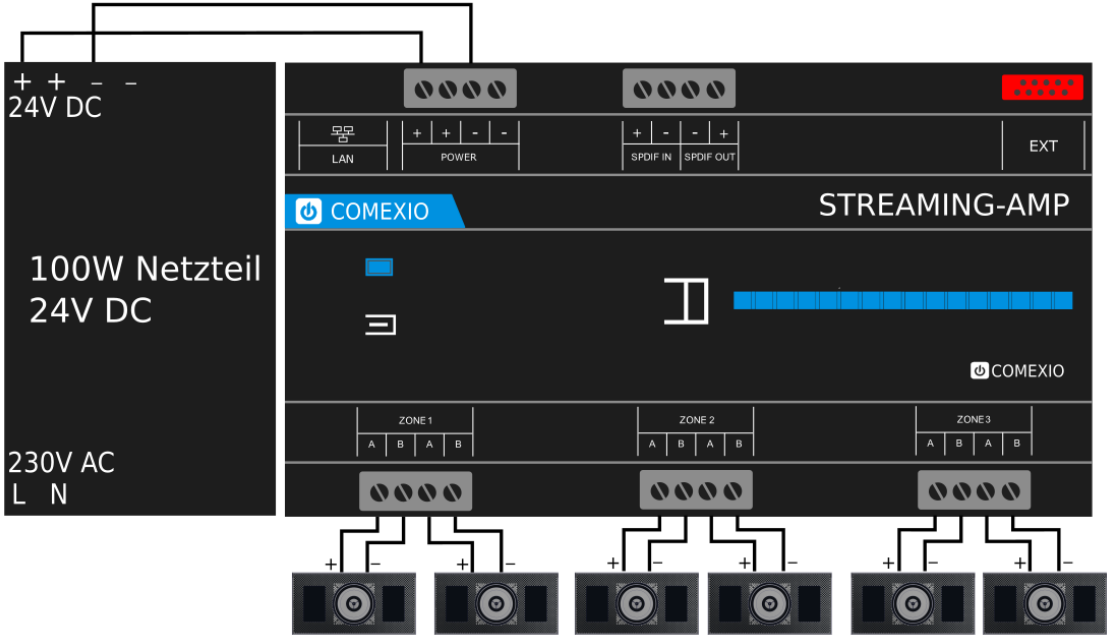

Verdrahtungsbeispiel

Wiring example



Empfohlenes Zubehör

Recommended Accessories

Streaming-Amp (CMS200)	
Extension-Amp (CME121)	
Stereo-Speaker (SP020)	
Blind-Speaker (SP030)	
Netzteil 24V DC 100W (ZC103) Power supply unit 24V DC 100W (ZC103)	



Eisenberger Str. 56a
67304 Kerzenheim
Deutschland

Telefon: 06351 - 47804 0
Fax: 06351 - 47804 99
<http://www.comexio.com>
info@comexio.com